

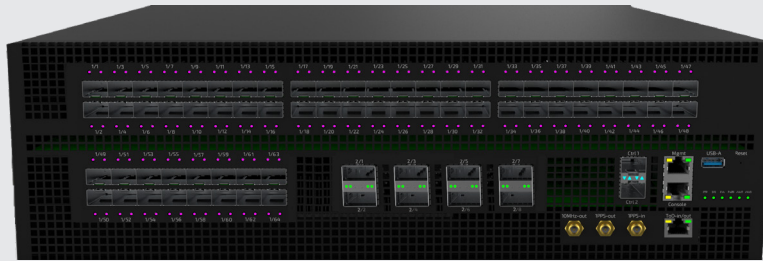

Advanced Programmable Switch

The **APS Networks® APS2172Q** delivers true processing versatility and programmability by combining the Intel® Tofino™ P4-programmable Ethernet switch ASIC and the Intel® Stratix® 10 MX FPGA in a practical form factor.

Our 3RU 25Gb switch offers HQoS and buffering support and the power of the FPGAs combined with the P4 programmability of the switching ASIC, make it extremely suitable for full-functionality BNG deployments, a range of cyber security, broadcasting and financial trading applications.





 **Data-Plane Programmability with P4 on the 3.2 Tbps Intel® Tofino™ ASIC:** Switch and prioritize network traffic based on industry/application-specific protocols and custom packet metadata.

 **Powerful Hardware:** A unique combination of 1 x Intel® Tofino™ BFN-T10-032Q-B0 chipset and 2 x Intel® Stratix® 10 MX FPGA combined with the compute power of the Intel® Ice Lake 3rd generation CPU and optional PTP time synchronization.

 **IEEE 1588v2 Precision Time Protocol:** Unique to the APS® range, with resolution of 3ns and frequency lock by OCXO. Timestamping is a vital enabler for real-world use cases across industries.

 **Management, Control and Network ports:** 64 x 1/10/25Gb user ports and 8 x 100Gb spine ports, rounded off with 1 x Console Port, 1 x RJ45 Management Port and USB-Port, as well as 2 x 1Gb SFP OoB Management Ports

 **Offload Processing with Intel® Stratix® 10 MX FPGA:** Process line rate data with dual fully reconfigurable FPGA hardware devices, incorporating 8Gb HBM and additional external memory (optional).

 **Integrated ONIE bootloader:** Dynamic updating and hardware repurposing with a wide choice of operating systems.

 **Compliance:** Complies to TIP OpenBNG SC-1 specification, 32K subscribers and up to 7 HQoS levels.

Use Cases: Broadband Network Gateway · Hybrid BNG/5G · 5G Integration · Next-Generation Internet · Load Balancing · Deep Packet Inspection · Network Packet Broker · Lawful Interception · DDoS Mitigation · Broadcast · Financial Trading

APS2172Q

Product Overview

The APS2172Q network switch is a unique combination of Intel® Tofino™, Intel® Stratix® 10 MX FPGA with the benefits of time synchronization and processor enabling a truly versatile and fully programmable data plane switch. The hardware architecture design uses an in-line Stratix® 10 MX 2100 series FPGA with the Tofino™ 3.2 quad pipeline Ethernet switch ASIC.

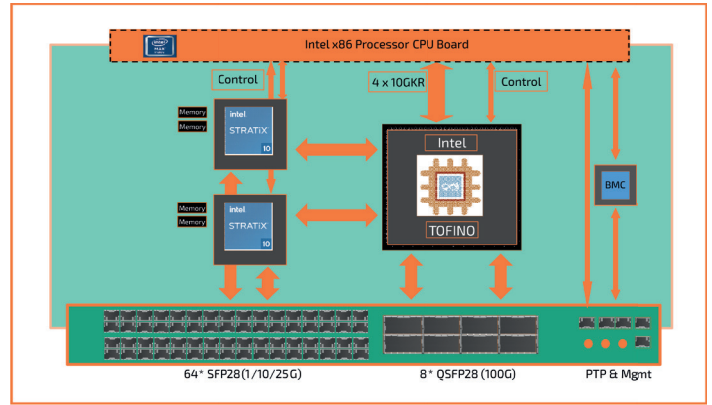

Pipeline Connectivity

The APS2172Q is designed to enable the user ports to connect to a single pipe and the uplink ports to connect to a second pipe enabling the additional Tofino pipes to be internal folded for additional processing.

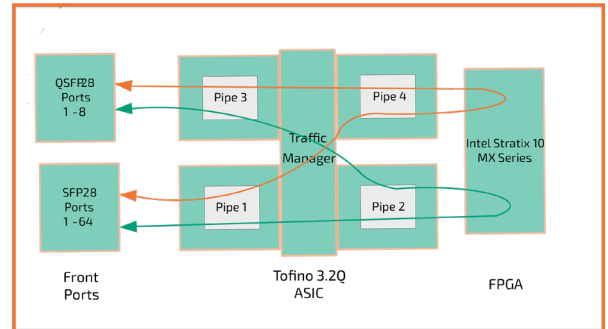

PTP Time Synchronization (optionally available)

The APS Networks® APS2172Q switch provides time synchronization across the switch enabling the PTP implementation across the FPGA and the Tofino™ ASIC providing highly accurate (3ns) time synchronization calculations with the different profiles for Telecom, Media & Broadcast, Default and IEEE standards.

Technical Specifications

Product Model	APS2172Q
Network Ports	4x1Gb/10Gb/25Gb, 8x100Gb
Max 100Gb Ports	8
Max 50Gb Ports	16
Max 40Gb Ports	8
Max 25Gb Ports	64+32
Max 10Gb Ports	64+32
Max 1Gb Ports	64
Throughput	1.6 Tbps
Time Synchronization	transparent & boundary clock optional
FPGA	Intel® Stratix® 10 MX 2100
CPU	4/8-core x86
System Memory	32 GB
Flash Storage Memory	2 x 16MB
System SSD Storage	480 GB
System / Packet buffer Memory	22 MB
Number of Pipelines	2
Management Ports	1x 1G RJ45 (10/100/1000)
RS-232 Serial Ports	1 (RJ45)
SDN Controller / Control Plane Ports	2 x 1G SFP cages
USB Ports	1
Hot-swap Power Supplies	3 (2+1 redundant)

Hot-swap Fans	9 (N+1 redundant)
Power Supplies	1500W max. (AC)
Power Supply Options	AC / DC
Air Flow	FTB/BTF
Rack Units	3RU
Supported Open Source Software	mion, Stratum, Ubuntu
Warranty	
Hardware Warranty	3 years bring-in warranty
Ordering Part Numbers	
APS2172Q with port-to-power airflow	tbd
1-year advanced exchange support, Software updates and setup support	tbd
3-year advanced exchange support, software updates and setup support	tbd
5-year advanced exchange support, software updates and setup support, incl. 2 year warranty extension	tbd
CPU Options	tbd
Spare Rack Sliding Kit	tbd
Additional SSD upgrade options	tbd
Upgrade to a total of 64GB RAM (2 modules needed)	tbd

Part codes, product configurations, components used, general product layout, features etc. are subject to change due to customer feedback. Early Access release dates and General Availability release dates are tentative dates only and are subject to change, especially with the shortage of components on the world-wide market. Availability dates are also affected by customer demand. For more details, please contact us.

The Content of this datasheet is preliminary and provided without obligation. It is not guaranteed to be complete, correct, timely, current or up-to-date. APS and APS Networks are registered trademarks. 210616_APS2172Q_V04